

Relative pressure switch type 620/625

Pressure range

-4 ... -900 mbar / 2 ... 6000 mbar



Type 620 and 625 pressure switches, with 13 pressure ranges, are suitable for liquids and gases. Body materials are available in plastic, brass and aluminium, with a choice of NBR, FPM, EPDM and silicone diaphragms.

Very high precision through finely tuned measurement stages and high long term stability. Rugged design and especially suitable for use in general industrial equipment construction, process technology and food automation.

- High accuracy by 13 ideally designed pressure range increments
- Switching differences adjustable
- High long term stability with reproducibility of switching points up to $< \pm 0.3$ mbar
- Customer specific switching points adjustable in factory
- Rugged industrial switch with excellent Price / performance ratio

Technical overview

Pressure range

Relative	2 ... 6000 mbar
Negative	-4 ... -900 mbar

Operating conditions

Medium		Liquids and neutral gases
Temperature	NBR based	0 ... +80 °C
	FPM	-10 ... +80 °C
	EPDM	-10 ... +80 °C
	Q (Silicone)	-40 ... +80 °C
	Ambient	+65 °C
	Storage	-40 ... +80 °C
Tolerable overload		See order code selection table
Lowest turn-on pressure		2 mbar
Lowest switching difference		1 mbar

Materials

Case		Fibreglass reinforced plastic
Materials in contact with the medium		NBR based
		EPDM
	Diaphragm	FPM
		Silicone
	Base type 620	ABS or PA
	Base type 625	Aluminium, nickel plated brass
Other components		X 5 CrNi 18-10, 1.4301
		Polyacetate (only at negative)

Electrical overview

Nominal voltage		250 VAC
Nominal current for resistive loading		1 A 6 A
Nominal current for motor loading		0.5 A 3 A
Contact system		Changeover contact
Service life	Mechanically	10 ⁶ switching cycle ¹⁾

Protection standard

Without cover		IP 00
With cover ²⁾		IP 54

Repeatability

±5% of the switching point	With diaphragm NBR based / Silicone	minimum ±0.3 mbar
±10% of the switching point	With diaphragm FPM / EPDM	minimum ±0.6 mbar

Electrical connections

Screw terminals (Option)		
Tab connectors (AMP)		6.3 mm
Cable gland PG 11		with cover

Pressure connections

Type 620	Inside / outside thread	M5 / M12x1
	Connection pipe / thread	Ø 6 mm / M12x1
Type 625	Thread with counter nut	M12x1 (CuZ nickel plated), G 1/8, G 1/4

Installation arrangement

For switching points calibrated in the factory Indicate installation arrangement.

Remark: By changing the mounting position the switching points also change. The adjustment ranges are in relation with the mounting position.

Weight

Type 620		~ 70 g
Type 625	with aluminium base	~ 100 g
	with base brass	~ 200 g

Packaging

Single packaging in cardboard boxes

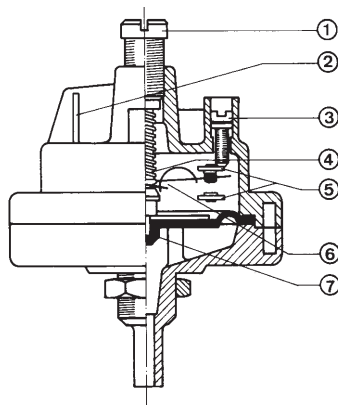

Legend to cross-section drawing

- 1 Switching point setting
- 2 AMP tab connectors
- 3 Switching difference setting
- 4 Compression spring
- 5 Changeover contact
- 6 Contact element
- 7 Diaphragm

¹⁾ The permitted switching difference has to be respected

²⁾ For installation arrangement electrical connections upward

Order code selection table						620.9	X	X	X	X
Pressure range ¹⁾	2 ... 8 mbar	p max. 30 mbar	pt ²⁾ 50 mbar	Switching capacity 250 VAC		1				
	6 ... 75 mbar	300 mbar	500 mbar	1 A		2				
	12.5 ... 80 mbar	300 mbar	500 mbar	6 A		3				
	12.5 ... 200 mbar	300 mbar	500 mbar	1 A		4				
	25 ... 220 mbar	300 mbar	500 mbar	6 A		5				
	Pressure connection / pressure case	Hose connection	Ø 6 mm and M12x1		ABS	... +70 °C		0		
Hose connection		Ø 6 mm and M12x1		PA 66	... +80 °C		1			
Inside thread		M5 and M12x1		ABS	... +70 °C		2			
Inside thread		M5 and M12x1		PA 66	... +80 °C		3			
Diaphragm material	NBR based									0
	FPM									2
	EPDM									4
	Q (Silicone)									6
Switching points (optional)	Two factory set switching points			(please specify on order)						W
	One factory set switching point high			(please specify on order)						R
	One factory set switching point low			(please specify on order)						U

Order code selection table						625.	X	X	X	X	X
Pressure mode	Relative					9					
	Negative					6					
Pressure range ¹⁾	2 ... 8 mbar	p max. 30 mbar	pt ²⁾ 50 mbar	Switching capacity 250 VAC		9	0				
	6 ... 75 mbar	300 mbar	500 mbar	1 A		9	1				
	12.5 ... 80 mbar	300 mbar	500 mbar	6 A		9	2				
	12.5 ... 200 mbar	300 mbar	500 mbar	1 A		9	3				
	25 ... 220 mbar	300 mbar	500 mbar	6 A		9	4				
	80 ... 2000 mbar	6000 mbar	10000 mbar	1 A		9	5				
	120 ... 2200 mbar	6000 mbar	10000 mbar	6 A		9	6				
	1000 ... 6000 mbar	6800 mbar	10000 mbar	6 A		9	7				
	-4 ... -30 mbar	-50 mbar	-100 mbar	1 A		6	1				
	-15 ... -80 mbar	-300 mbar	-500 mbar	1 A		6	2				
	-30 ... -150 mbar	-300 mbar	-500 mbar	6 A		6	3				
	-50 ... -600 mbar	-1000 mbar	-1000 mbar	6 A		6	4				
	-100 ... -900 mbar	-1000 mbar	-1000 mbar	6 A		6	5				
	Pressure connection / pressure case	G 1/8	Aluminium						1		
		M12x1	Aluminium						2		
		G 1/4	Brass						3		
G 1/4		Aluminium						4			
G 1/4		Nickel plated brass 5µm						A			
G 1/8		Brass						B			
Diaphragm material	NBR based									0	
	FPM									2	
	EPDM									4	
	Q (Silicone)									6	
Switching points (optional)	Two factory set switching points			(please specify on order)						W	
	One factory set switching point high			(please specify on order)						R	
	One factory set switching point low			(please specify on order)						U	

Accessories ³⁾		Order number
Cover of PG11 on the side		105836
Mounting bracket with hole Ø 12.5 mm for M12		104259
Mounting bracket with hole Ø 14 mm for G 1/4		102872
Connector set (Tab connectors AMP)		103479
Screw clamps set		103491
Calibration certificate		104551

¹⁾ Other pressure ranges on request

²⁾ pt = test pressure

³⁾ Accessories supplied loose

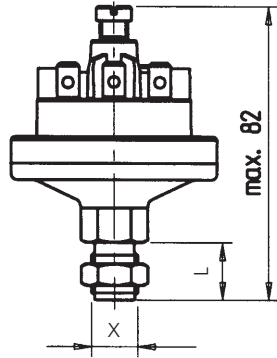
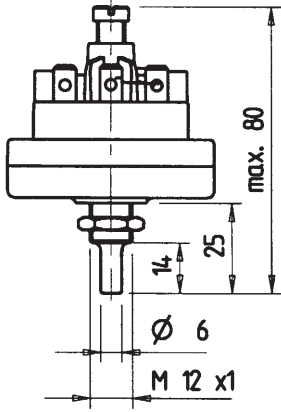

X	L
G 1/4	16
G 1/2	16
M12X1	14

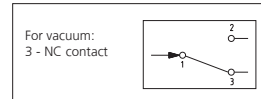
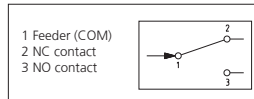
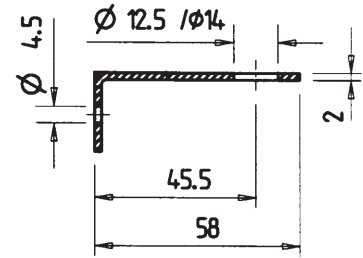
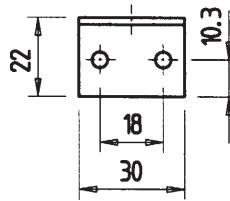
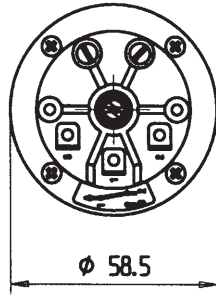
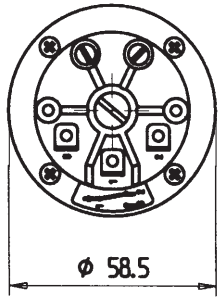
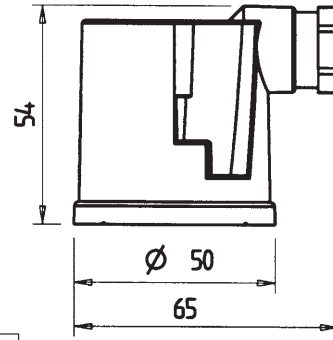

Setting ranges

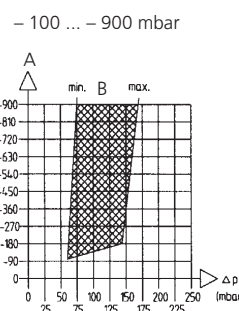
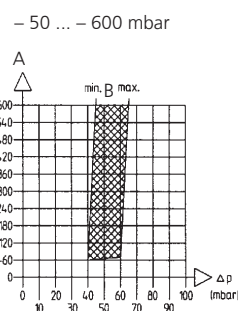
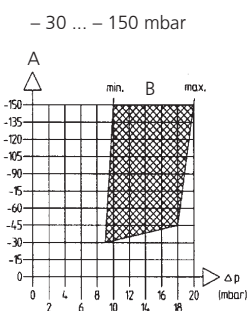
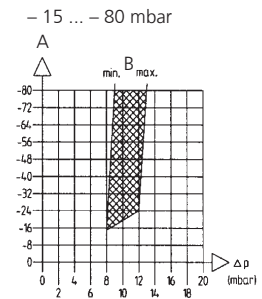
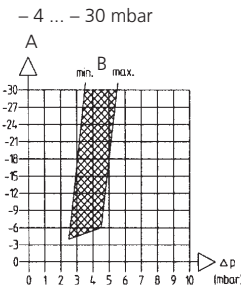
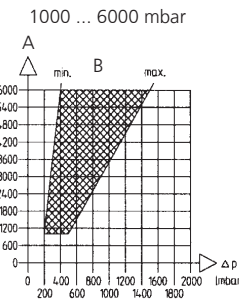
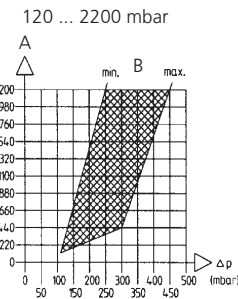
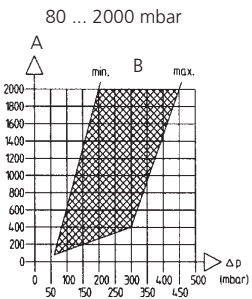
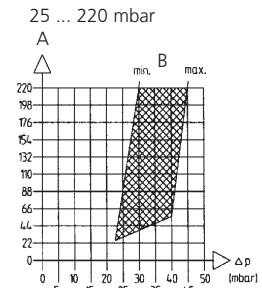
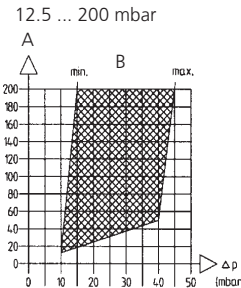
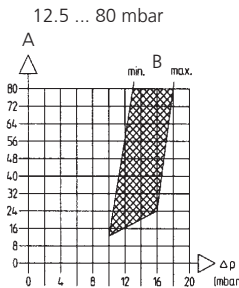
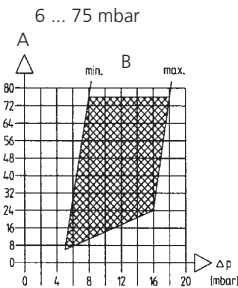
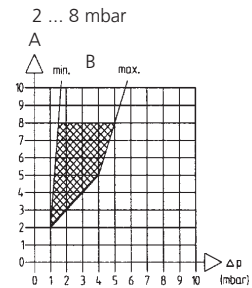

A Upper switching point (mbar)
B Distance between contacts

Huba Control AG
Headquarters

Industriestrasse 17
5436 Würenlos
Telefon +41 (0) 56 436 82 00
Telefax +41 (0) 56 436 82 82
info.ch@hubacontrol.com

Huba Control AG
Niederlassung Deutschland

Schlattgrabenstrasse 24
72141 Walddorfhäslach
Telefon +49 (0) 7127 23 93 00
Telefax +49 (0) 7127 23 93 20
info.de@hubacontrol.com

Huba Control SA
Succursale France

Rue Lavoisier
Technopôle Forbach-Sud
57602 Forbach Cedex
Téléphone +33 (0) 387 847 300
Télécopieur +33 (0) 387 847 301
info.fr@hubacontrol.com

Huba Control AG
Vestiging Nederland

Hamseweg 20A
3828 AD Hoogland
Telefoon +31 (0) 33 433 03 66
Telefax +31 (0) 33 433 03 77
info.nl@hubacontrol.com

Huba Control AG
Branch Office United Kingdom

Unit 13 Berkshire House
County Park Business Centre
Shrivenham Road
Swindon - Wiltshire SN1 2NR
Phone +44 (0) 1993 776667
Fax +44 (0) 1993 776671
info.uk@hubacontrol.com